

## COLTELLI PIALLA, PER PIALLATRICI INDUSTRIALI

### PLANING KNIVES, FOR INDUSTRIAL PLANING MACHINES

Coltelli per piallatrici industriali realizzati con i migliori acciai e con trattamenti termici d'ultima generazione che garantiscono elevate prestazioni e lunga durata.

Forniti già bilanciati a coppie, terne o quaterne secondo la richiesta. Disponibili in varie misure ed in quattro versioni: in acciaio HSS 18%W, 13% Cromo o Chrom-Vanadium; T.C.T. (con inserto in Carburio di Tungsteno micrograna K10).

Planing knives for industrial planing machines, made of the best steels and heat-treated with last-generation techniques that guarantee very high performances and long life of the blade.

Supplied already balanced in sets of 2, 3 or 4 pieces, according to the request. Available in a wide range of sizes and in four versions: HSS 18%W, 13% Chrome or Chrome-Vanadium steel; T.C.T. (Tungsten Carbide micrograin K10 tipped).

Couteaux pour les raboteuses industrielles réalisées avec les meilleurs aciers et avec les traitements thermiques de dernière génération qui garantissent des prestations élevées et longue durée de vie de l'util.

Fournis déjà équilibrés aux couples, groupes de trois ou quatre selon la demande. Disponibles dans différentes mesures et dans quatre versions: en acier HSS 18 %W, 13% Chrome ou Chrom-Vanadium; T.C.T. (avec segments en carbure de tungstène micrograin K10).

Cuchillos para acepilladoras industriales realizados con los mejores aceros y con tratamientos térmicos de última generación que garantizan elevadas prestaciones y larga duración.

Se suministran ya calibrados a dos, tres, cuatro, según demanda. Disponibles en varias medidas y en cuatro versiones: en acero rápido HSS 18%W, 13% Cromo ó Cromo-Vanadio; T.C.T. (con inserción de Carburio de Tungsteno micrograno K10)

## COLTELLI PIALLA HSS 18% W

### HSS 18% W PLANING KNIVES

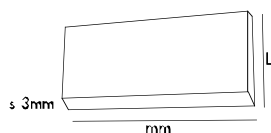

CARBONIO 0,75%  
CROMO 4,1%  
VANADIO 1,1%  
WOLFRAMIO 18%

CARBON 0,75%  
CHROME 4,1%  
VANADIUM 1,1%  
TUNGSTEN 18%

| mm   | L 20 mm<br>COD. | L 25 mm<br>COD. | L 30 mm<br>COD. | L 35 mm<br>COD. |
|------|-----------------|-----------------|-----------------|-----------------|
| 100  | 04310020        | 04310025        | 04310030        | 04310035        |
| 150  | 04315020        | 04315025        | 04315030        | 04315035        |
| 200  | 04320020        | 04320025        | 04320030        | 04320035        |
| 250  | 04325020        | 04325025        | 04325030        | 04325035        |
| 260  | 04326020        | 04326025        | 04326030        | 04326035        |
| 300  | 04330020        | 04330025        | 04330030        | 04330035        |
| 350  | 04335020        | 04335025        | 04335030        | 04335035        |
| 400  | 04340020        | 04340025        | 04340030        | 04340035        |
| 410  |                 |                 | 04341030        | 04341035        |
| 430  |                 |                 | 04343030        | 04343035        |
| 500  |                 |                 | 04350030        | 04350035        |
| 510  |                 |                 | 04351030        | 04351035        |
| 520  |                 |                 | 04352030        | 04352035        |
| 530  |                 |                 | 04353030        | 04353035        |
| 600  |                 |                 | 04360030        | 04360035        |
| 610  |                 |                 | 04361030        | 04361035        |
| 630  |                 |                 | 04363030        | 04363035        |
| 710  |                 |                 | 04371030        | 04371035        |
| 810  |                 |                 | 04381030        | 04381035        |
| 850  |                 |                 | 04385030        | 04385035        |
| 1070 | 043107020       | 043107025       | 043107030       | 043107035       |

## COLTELLI PIALLA 13% CROMO

### HIGH CHROME (13%) PLANING KNIVES

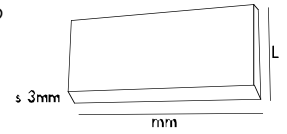

| mm   | L 20 mm<br>COD. | L 25 mm<br>COD. | L 30 mm<br>COD. | L 35 mm<br>COD. |
|------|-----------------|-----------------|-----------------|-----------------|
| 100  | 04210020        | 04210025        | 04210030        | 04210035        |
| 150  | 04215020        | 04215025        | 04215030        | 04215035        |
| 200  | 04220020        | 04220025        | 04220030        | 04220035        |
| 250  | 04225020        | 04225025        | 04225030        | 04225035        |
| 260  | 04226020        | 04226025        | 04226030        | 04226035        |
| 300  | 04230020        | 04230025        | 04230030        | 04230035        |
| 350  | 04235020        | 04235025        | 04235030        | 04235035        |
| 400  | 04240020        | 04240025        | 04240030        | 04240035        |
| 410  |                 |                 | 04241030        | 04241035        |
| 430  |                 |                 | 04243030        | 04243035        |
| 500  |                 |                 | 04250030        | 04250035        |
| 510  |                 |                 | 04251030        | 04251035        |
| 520  |                 |                 | 04252030        | 04252035        |
| 530  |                 |                 | 04253030        | 04253035        |
| 600  |                 |                 | 04260030        | 04260035        |
| 610  |                 |                 | 04261030        | 04261035        |
| 630  |                 |                 | 04263030        | 04263035        |
| 710  |                 |                 | 04271030        | 04271035        |
| 810  |                 |                 | 04281030        | 04281035        |
| 850  |                 |                 | 04285030        | 04285035        |
| 1070 |                 | 042107025       | 042107030       | 042107035       |

CARBONIO 2%  
CROMO 13%  
WOLFRAMIO 0,75%

CARBON 2%  
CHROME 13%  
TUNGSTEN 0,75%

## COLTELLI PIALLA CHROM-VANADIUM (CV)

### CHROM-VANADIUM PLANING KNIVES

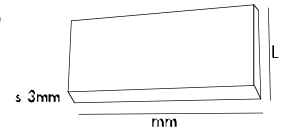

| mm   | L 20 mm<br>COD. | L 25 mm<br>COD. | L 30 mm<br>COD. | L 35 mm<br>COD. |
|------|-----------------|-----------------|-----------------|-----------------|
| 100  | 04110020        | 04110025        | 04110030        | 04110035        |
| 150  | 04115020        | 04115025        | 04115030        | 04115035        |
| 200  | 04120020        | 04120025        | 04120030        | 04120035        |
| 250  | 04125020        | 04125025        | 04125030        | 04125035        |
| 260  | 04126020        | 04126025        | 04126030        | 04126035        |
| 300  | 04130020        | 04130025        | 04130030        | 04130035        |
| 350  | 04135020        | 04135025        | 04135030        | 04135035        |
| 400  | 04140020        | 04140025        | 04140030        | 04140035        |
| 410  |                 |                 | 04141030        | 04141035        |
| 430  |                 |                 | 04143030        | 04143035        |
| 500  |                 |                 | 04150030        | 04150035        |
| 510  |                 |                 | 04151030        | 04151035        |
| 520  |                 |                 | 04152030        | 04152035        |
| 530  |                 |                 | 04153030        | 04153035        |
| 600  |                 |                 | 04160030        | 04160035        |
| 610  |                 |                 | 04161030        | 04161035        |
| 630  |                 |                 | 04163030        | 04163035        |
| 710  |                 |                 | 04171030        | 04171035        |
| 810  |                 |                 | 04181030        | 04181035        |
| 850  |                 |                 | 04185030        | 04185035        |
| 1070 |                 |                 | 041107030       | 041107035       |

CARBONIO 1%  
CROMO 1,5%  
VANADIO 0,15%

CARBON 1%  
CHROME 1,5%  
VANADIUM 0,15%

## COLTELLI PIALLA CON RIPORTO IN METALLO DURO MICROGRANA K10

T.C.T. MICROGRAIN K10 PLANING KNIVES

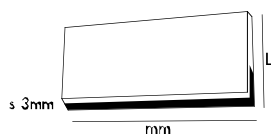

| mm  | L 20 mm<br>COD. | L 25 mm<br>COD. | L 30 mm<br>COD. | L 35 mm<br>COD. |
|-----|-----------------|-----------------|-----------------|-----------------|
| 100 | 04510020        | 04510025        | 04510030        | 04510035        |
| 150 | 04515020        | 04515025        | 04515030        | 04515035        |
| 200 | 04520020        | 04520025        | 04520030        | 04520035        |
| 250 | 04525020        | 04525025        | 04525030        | 04525035        |
| 260 | 04526020        | 04526025        | 04526030        | 04526035        |
| 300 | 04530020        | 04530025        | 04530030        | 04530035        |
| 350 | 04535020        | 04535025        | 04535030        | 04535035        |
| 400 | 04540020        | 04540025        | 04540030        | 04540035        |
| 410 |                 |                 | 04541030        | 04541035        |
| 430 |                 |                 | 04543030        | 04543035        |
| 500 |                 |                 | 04550030        | 04550035        |
| 510 |                 |                 | 04551030        | 04551035        |
| 520 |                 |                 | 04552030        | 04552035        |
| 530 |                 |                 | 04553030        | 04553035        |
| 600 |                 |                 | 04560030        | 04560035        |
| 610 |                 |                 | 04561030        | 04561035        |
| 630 |                 |                 | 04563030        | 04563035        |
| 710 |                 |                 | 04571030        | 04571035        |
| 860 |                 |                 | 04586030        | 04586035        |

## COLTELLI REVERSIBILI IN METALLO DURO TUNGSTEN CARBIDE REVERSIBLE BLADES



| ART.  | mm           | COD.        | 2 pz | 10 pz      |
|-------|--------------|-------------|------|------------|
| R75   | 75,5x5,5x1,1 | 045R0755B   |      | 045R0755   |
| R80   | 80,5x5,9x1,2 | 045R0805B   |      | 045R0805   |
| R82   | 82x5,5x1,1   | 045R0820B   |      | 045R0820   |
| R92   | 92x5,5x1,2   | 045R0920B   |      | 045R0920   |
| R102  | 102x5,5x1,2  | 045R1020B   |      | 045R1020   |
| R82BD | 82x5,5x1,1   | 045R0820BDB |      | 045R0820BD |

PER PIALLETTI BLACK&DECKER (VECCHIO TIPO) for Black&Decker jack planes (old type)

## COLTELLI PER PIALLATRICI PORTATILI PLANING KNIVES FOR PORTABLE MACHINES

| mm        | COD.      | tipo    |
|-----------|-----------|---------|
| 80x27x2,9 | 042080    | ELU     |
| 82x29x3   | 042082    | B.&D.   |
| 155x32x3  | 04215532A | MAKITA  |
| 170x35x3  | 04217035A | MAKITA  |
| 200x25x3  | 04220025A | CEMA    |
| 220x16x3  | 040220    | ZINKEN  |
| 260x16x3  | 040260    | ZINKEN  |
| 260x30x3  | 04226030A | CEMA    |
| 260x21x3  | 04226021  | DE WALT |
| 300x18x3  | 040300    | ZINKEN  |

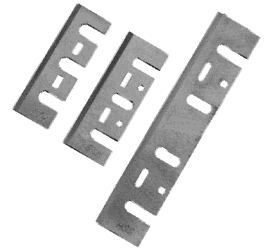

## SERRATED KNIVES COLTELLI RIGATI

blades BARRE L. 650 mm

| mm | COD.      |
|----|-----------|
| 40 | 040R65040 |
| 50 | 040R65050 |
| 60 | 040R65060 |
| 70 | 040R65070 |

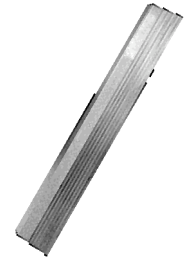

serrated knives COLTELLI RIGATI

|     | LL 40 mm | LL 50 mm | LL 60 mm | LL 70 mm |
|-----|----------|----------|----------|----------|
| mm  |          |          |          |          |
| 40  |          |          |          |          |
| 50  |          |          |          |          |
| 60  |          |          |          |          |
| 80  |          |          |          |          |
| 100 |          |          |          |          |
| 130 |          |          |          |          |
| 150 |          |          |          |          |
| 180 |          |          |          |          |
| 230 |          |          |          |          |
| 260 |          |          |          |          |

## LAME E DISCHI SU DISEGNO

BLADES AND KNIVES MANUFACTURED ON DRAWING

### COLTELLI CIRCOLARI CIRCULAR KNIVES

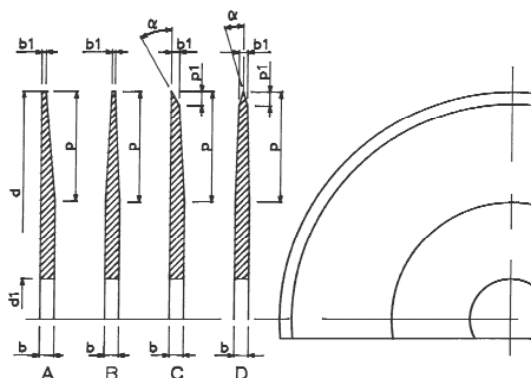

Realizzati in acciaio HSS, CV o Inox, a uno o più biselli. Adatti al taglio di: gomma; plastica; carta; pelle; stoffa; materiali sintetici; prodotti alimentari. Esecuzione su disegno o a campione. Prezzi a preventivo.

Made from HSS, tool steel or stainless steel, with one or more bevels. Suitable for cutting: rubber; plastics; paper; leather; cloth; synthetic materials; foodstuffs. Manufactured to drawing or sample. Ask for our quotation.

Réalisés en acier HSS, CV ou inoxydable, à un ou plusieurs biseaux. Pour couper: caoutchouc; plastique; papier; peau; tissu; matériaux synthétiques; produits denrées alimentaires. Exécution sur plan ou à l'échantillon. Prix sur devis.

Fabricados en acero rápido HSS, CV ó Inox., con uno o más biseles. Aptos para el corte de: goma, plástico, papel, piel, tejidos, materiales sintéticos, productos alimentarios. Ejecución sobre diseño o muestra. Precios según presupuesto.

### LAME INDUSTRIALI INDUSTRIAL BLADES

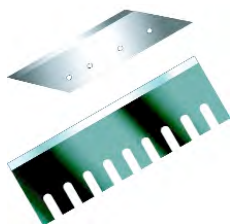

Realizziamo su richiesta lame industriali per il taglio di legno e derivati, carta, cartone, pelle, stoffa, gomma, plastica, materiali sintetici, lamiera metalliche. Lunghezza massima delle lame: 4.200mm. Disponibili in numerosi acciai. Richiedere offerta, secondo disegno o campione.

We manufacture industrial blades on demand for cutting wood and wood composites, paper, carton, leather, cloth, rubber, plastic, synthetic materials, metal sheets. Maximum length of the blade: 4.200mm. Made from various steel types. Ask for quotation, price depending on drawing or sample.

Nous réalisons sur demande les lames industrielles pour la coupe de bois et dérivés, papier, carton, peaux, tissu, gomme, matériaux synthétiques, tôles métalliques. Longueur maximum des lames: 4.200mm. Disponibles dans de nombreux aciers. Offre sur demande, selon dessin ou modèle.

Fabricamos sobre demanda cuchillas industriales para el corte de madera y derivados, papel, cartón, piel, tejidos, goma, plástico, materiales sintéticos, láminas metálicas. Longitud máxima de las cuchillas: 4.200 mm. Disponibles en aceros diversos. Ofertas sobre consulta, según diseño ó muestra.